



Compact Urban Villa Dollhouse

Assembly instruction

Puppenhaus Stadtvilla kompakt

Aufbauanleitung

Maison de poupée Villa compacte

Notice de montage

Casa delle bambole, villa di città compatta

Istruzioni di montaggio

Casa de muñecas City Villa Compacta

Instrucciones de montaje

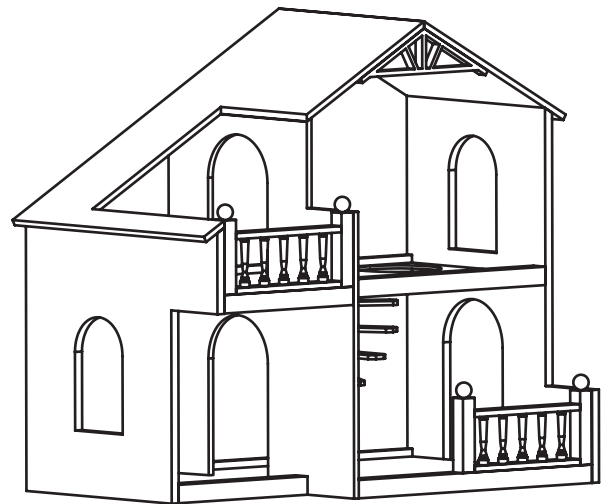

Art. Nr. 12277

Follow us on:

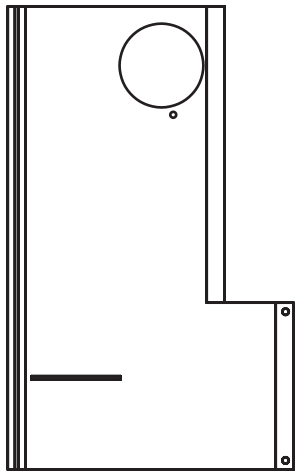
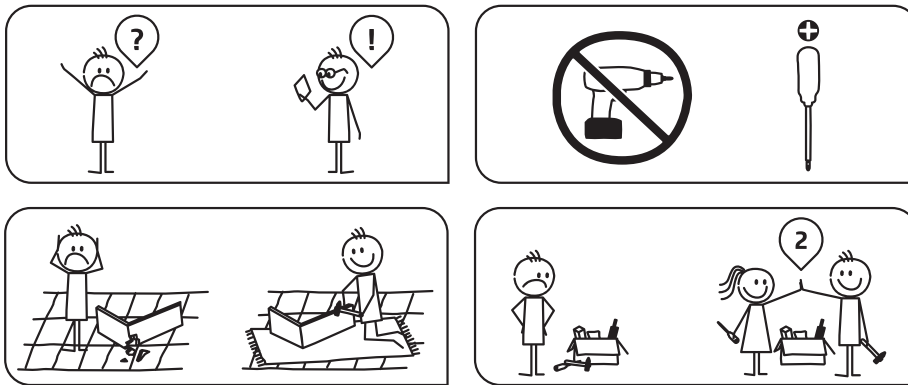

A x 1

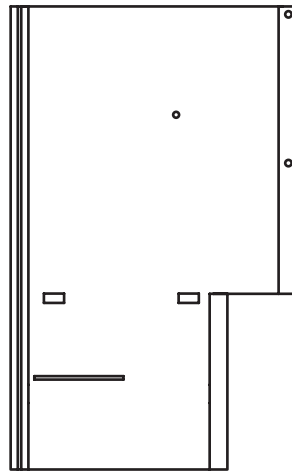

B x 1



C x 1

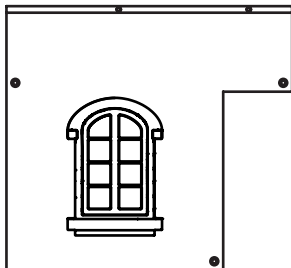

D x 1

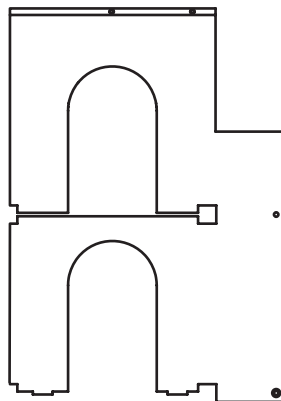

E x 1

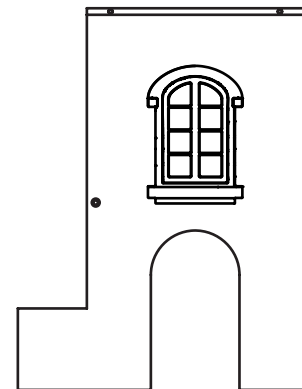

F x 1









WARNING! Adult assembly required. ACHTUNG! Aufbau nur durch einen Erwachsenen. ATTENTION! Assemblage par un adulte requis. AVVERTENZA! Richiesto assemblaggio da parte di un adulto. ADVERTENCIA! Se requiere ensamblaje por un adulto.

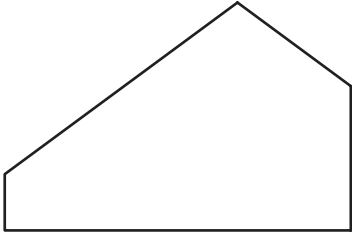

Art. Nr. 12277

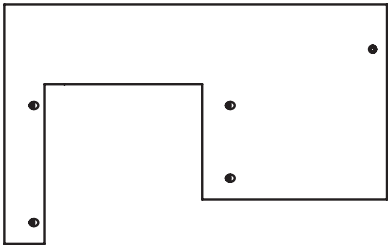
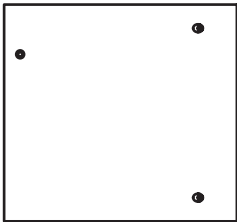
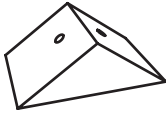
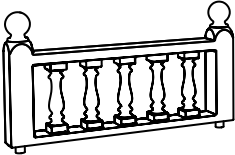
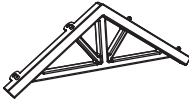
Follow us on:



| | | |
|---|--|--|
|  G x 1 |  H x 1 |  I x 1 |
|  J x 1 |  K x 1 |  O x 1 |
|  P x 2 | |  Q x 1 |
|  L x 16 |  M x 2 |  N x 4 |

①

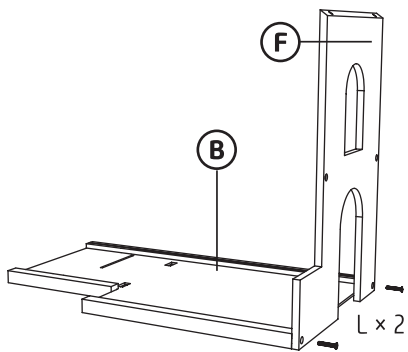

②

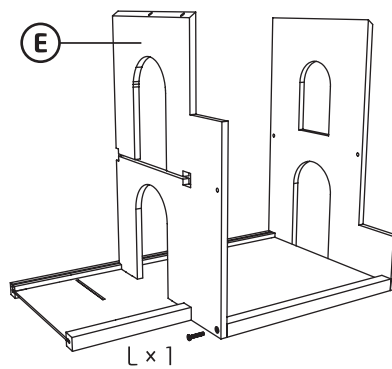

③

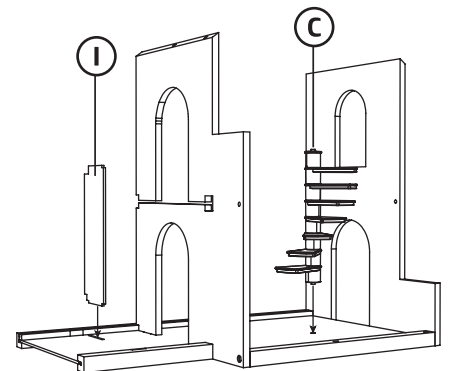

WARNING! Adult assembly required. ACHTUNG! Aufbau nur durch einen Erwachsenen. ATTENTION! Assemblage par un adulte requis. AVVERTENZA! Richiesto assemblaggio da parte di un adulto. ADVERTENCIA! Se requiere ensamblaje por un adulto.

Art. Nr. 12277

4

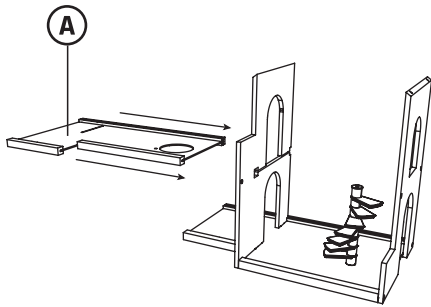

5

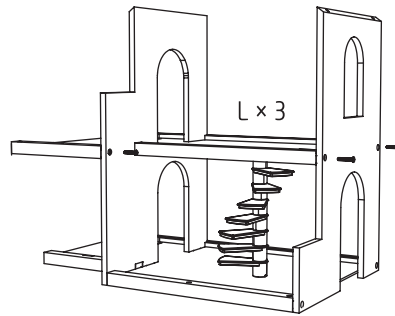

6

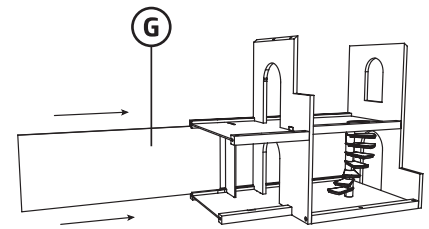

7

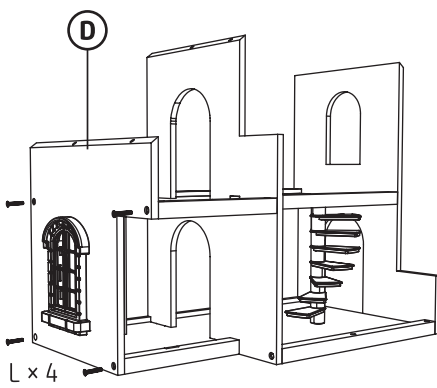

8

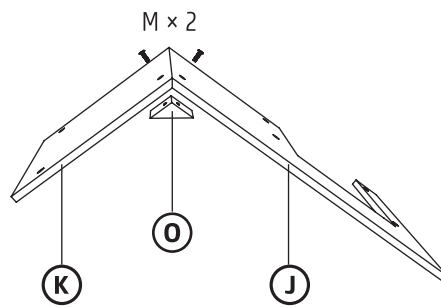

9

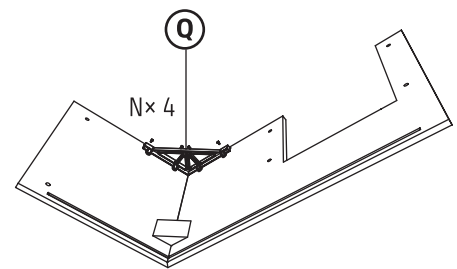

10

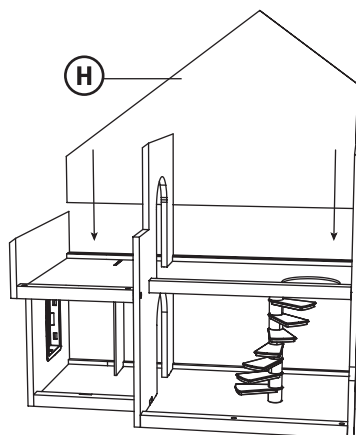

11

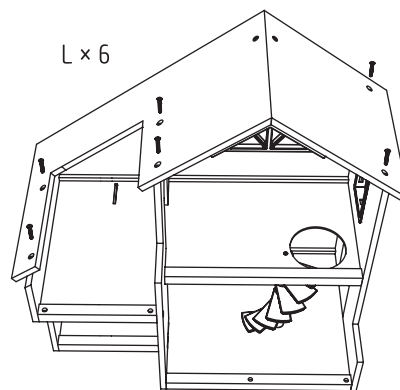

12

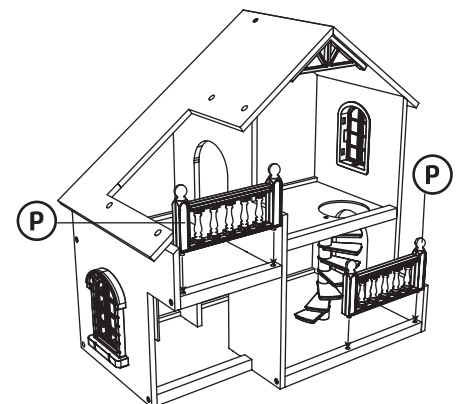

WARNING! Adult assembly required. ACHTUNG! Aufbau nur durch einen Erwachsenen. ATTENTION! Assemblage par un adulte requis. AVVERTENZA! Richiesto assemblaggio da parte di un adulto. ADVERTENCIA! Se requiere ensamblaje por un adulto.